

Site Preparation and  
Installation Guide

# Keysight AXIe 14-Slot Chassis M9514A





# Notices

© Keysight Technologies, Inc. 2014

No part of this manual may be reproduced in any form or by any means (including electronic storage and retrieval or translation into a foreign language) without prior agreement and written consent from Keysight Technologies, Inc. as governed by United States and international copyright laws.

## Manual Part Number

M9514-90007

## Edition

Second Edition, September 2014  
Printed in Malaysia

Keysight Technologies, Inc.  
1400 Fountaingrove Parkway  
Santa Rosa, CA 95403 USA

## Trademarks

AXIe is a registered trademark of the AXIe Consortium.

PXI is a registered trademark of the PXI Systems Alliance.

PICMG<sup>®</sup>, Compact PCI<sup>®</sup>, and AdvancedTCA<sup>®</sup> are registered trademarks of the PCI Industrial Computer Manufacturers Group.

PCI-SIG<sup>®</sup>, PCI Express<sup>®</sup>, and PCIe<sup>®</sup> are registered trademarks of PCI-SIG.

## Sales and Technical Support

To contact Keysight for sales and technical support, refer to the support links on the following Keysight websites:

[www.keysight.com/find/M9514AA](http://www.keysight.com/find/M9514AA) (product-specific information and support, software and documentation updates)

[www.keysight.com/find/assist](http://www.keysight.com/find/assist) (world-wide contact information for repair and service)

Information on preventing damage to your Keysight equipment can be found at [www.keysight.com/find/tips](http://www.keysight.com/find/tips).

## Declaration of Conformity

Declarations of Conformity for this product and for other Keysight products may be downloaded from the Web. Go to <http://keysight.com/go/conformity> and click on "Declarations of Conformity." You can then search by product number to find the latest Declaration of Conformity.

## Warranty

THE MATERIAL CONTAINED IN THIS DOCUMENT IS PROVIDED "AS IS," AND IS SUBJECT TO BEING CHANGED, WITHOUT NOTICE, IN FUTURE EDITIONS. FURTHER, TO THE MAXIMUM EXTENT PERMITTED BY APPLICABLE LAW, KEYSIGHT DISCLAIMS ALL WARRANTIES, EITHER EXPRESS OR IMPLIED, WITH REGARD TO THIS MANUAL AND ANY INFORMATION CONTAINED HEREIN, INCLUDING BUT NOT LIMITED TO THE IMPLIED WARRANTIES OF MERCHANTABILITY AND FITNESS FOR A PARTICULAR PURPOSE. KEYSIGHT SHALL NOT BE LIABLE FOR ERRORS OR FOR INCIDENTAL OR CONSEQUENTIAL DAMAGES IN CONNECTION WITH THE FURNISHING, USE, OR PERFORMANCE OF THIS DOCUMENT OR OF ANY INFORMATION CONTAINED HEREIN. SHOULD KEYSIGHT AND THE USER HAVE A SEPARATE WRITTEN AGREEMENT WITH WARRANTY TERMS COVERING THE MATERIAL IN THIS DOCUMENT THAT CONFLICT WITH THESE TERMS, THE WARRANTY TERMS IN THE SEPARATE AGREEMENT SHALL CONTROL.

## Technology Licenses

The hardware and/or software described in this document are furnished under a license and may be used or copied only in accordance with the terms of such license.

## DFARS/Restricted Rights Notices

If software is for use in the performance of a U.S. Government prime contract or subcontract, Software is delivered and licensed as "Commercial computer software" as defined in DFAR 252.227-7014 (June 1995), or as a "commercial item" as defined in FAR 2.101(a) or as "Restricted computer software" as defined in FAR 52.227-19 (June 1987) or any equivalent agency regulation or contract clause. Use, duplication or disclosure of Software is subject to Keysight Technologies' standard commercial license terms, and non-DOD Departments and Agencies of the U.S. Government will receive no greater than Restricted Rights as defined in FAR 52.227-19(c)(1-2) (June 1987). U.S. Government users will receive no greater than Limited Rights as defined in FAR 52.227-14 (June 1987) or DFAR 252.227-7015 (b)(2) (November 1995), as applicable in any technical data.

# Safety Information

The following general safety precautions must be observed during all phases of operation of this instrument. Failure to comply with these precautions or with specific warnings or operating instructions in the product manuals violates safety standards of design, manufacture, and intended use of the instrument. Keysight Technologies assumes no liability for the customer's failure to comply with these requirements.

## General

**Do not use this product in any manner not specified by the manufacturer. The protective features of this product must not be impaired if it is used in a manner specified in the operation instructions.**

### Before Applying Power

**Verify that all safety precautions are taken. Make all connections to the unit before applying power. Note the instrument's external markings described under "Safety Symbols".**

### Ground the Instrument

Keysight chassis' are provided with a grounding-type power plug. The instrument chassis and cover must be connected to an electrical ground to minimize shock hazard. The ground pin must be firmly connected to an electrical ground (safety ground) terminal at the power outlet. Any interruption of the protective (grounding) conductor or disconnection of the protective earth terminal will cause a potential shock hazard that could result in personal injury.

### Do Not Operate in an Explosive Atmosphere

Do not operate the Keysight module/chassis in the presence of flammable gases or fumes.

### Do Not Operate Near Flammable Liquids

Do not operate the Keysight module/chassis in the presence of flammable liquids or near containers of such liquids.

### Do Not Remove Instrument Cover

Only qualified, service-trained personnel who are aware of the hazards involved should remove instrument covers. Always disconnect the power cable and any external circuits before removing the instrument cover.

### Cleaning

Clean the outside of the Keysight module/chassis with a soft, lint-free, slightly dampened cloth. Do not use detergent or chemical solvents.

### Keep away from live circuits

Operating personnel must not remove equipment covers or shields. Procedures involving the removal of covers and shields are for use by service-trained personnel only. Under certain conditions, dangerous voltages may exist even with the equipment switched off. To avoid dangerous electrical shock, DO NOT perform procedures involving cover or shield removal unless you are qualified to do so.

### DO NOT operate damaged equipment

Whenever it is possible that the safety protection features built into this product have been impaired, either through physical damage, excessive moisture, or any other reason, REMOVE POWER and do not use the product until safe operation can be verified by service-trained personnel. If necessary, return the product to an Keysight Technologies Sales and Service Office for service and repair to ensure the safety features are maintained.

### DO NOT block the primary disconnect

The primary disconnect device is the appliance connector/power cord when a chassis used by itself, but when installed into a rack or system the disconnect may be impaired and must be considered part of the installation.

### Do Not Modify the Instrument

Do not install substitute parts or perform any unauthorized modification to the product. Return the product to an Keysight Sales and Service Office to ensure that safety features are maintained.

### In Case of Damage

Instruments that appear damaged or defective should be made inoperative and secured against unintended operation until they can be repaired by qualified service personnel.

### Cautions

Do NOT block vents and fan exhaust: To ensure adequate cooling and ventilation, leave a gap of at least 50mm (2") around vent holes on both sides of the chassis.

Do NOT operate with empty slots: To ensure proper cooling and avoid damaging equipment, fill each empty slot with an AXle filler panel module.

Do NOT stack free-standing chassis: Stacked chassis should be rack-mounted.

All modules are grounded through the chassis: During installation, tighten each module's retaining screws to secure the module to the chassis and to make the ground connection.

## CAUTION















A CAUTION denotes a hazard. It calls attention to an operating procedure or practice that, if not correctly performed or adhered to, could result in damage to the product or loss of important data. Do not proceed beyond a CAUTION notice until the indicated conditions are fully understood and met.

## WARNING

A WARNING denotes a hazard. It calls attention to an operating procedure or practice, that, if not correctly performed or adhered to, could result in personal injury or death. Do not proceed beyond a WARNING notice until the indicated conditions are fully understood and met.

## Safety Symbols

Products display the following symbols:

	<b>Warning, risk of electric shock</b>
	<b>Refer to manual for additional safety information.</b>
	<b>Earth Ground.</b>
	<b>Protective Earth Ground terminal</b>
	<b>Chassis Ground.</b>
	<b>Alternating Current (AC).</b>
	<b>Three-Phase Alternating Current</b>
	<b>Direct Current (DC).</b>
	<b>Both direct and alternating current</b>
	<b>Terminal is at earth potential.</b>
	<b>Terminal for Neutral conductor on properly installed equipment</b>
	<b>Terminal for Line conductor on properly installed equipment</b>
	<b>Standby Power. Unit is not completely disconnected from AC mains when switch is in standby.</b>
	<b>Antistatic precautions should be taken.</b>
CAT I CAT II CAT III CAT IV	<b>IEC Measurement Category I, II, III, or IV</b>

For localized Safety Warnings, Refer to Agilent Safety document (p/n 5185-8500) on the product CD.



The CSA mark is a registered trademark of the Canadian Standards Association and indicates compliance to the standards laid out by them. Refer to the product Declaration of Conformity for details.



Notice for European Community: This product complies with the relevant European legal Directives: EMC Directive (2004/108/EC) and Low Voltage Directive (2006/95/EC).



The Regulatory Compliance Mark (RCM) mark is a registered trademark. This signifies compliance with the Australia EMC Framework regulations under the terms of the Radio Communication Act of 1992.

### ICES/NMB-001

ICES/NMB-001 indicates that this ISM device complies with the Canadian ICES-001.



This symbol represents the time period during which no hazardous or toxic substance elements are expected to leak or deteriorate during normal use. Forty years is the expected useful life of this product.



South Korean Class A EMC Declaration. This equipment is Class A suitable for professional use and is for use in electromagnetic environments outside of the home.

A 급 기기 ( 업무용 방송통신기자재 ) 이 기기는 업무용 ( A 급 ) 전자파적합 기기로서 판매 또는 사용자는 이 점을 주의하시기 바라 며 , 가정외의 지역에서 사용하는 것을 목적으로 합니다.



Waste Electrical and Electronic Equipment (WEEE) Directive 2002/96/EC

This product complies with the WEEE Directive (2002/96/EC) marking requirement. The affixed product label (see below) indicates that you must not discard this electrical/electronic product in domestic household waste.

Product Category: With reference to the equipment types in the WEEE directive Annex 1, this product is classified as a "Monitoring and Control instrumentation" product.

Do not dispose in domestic household waste.

To return unwanted products, contact your local Keysight office, or see [www.keysight.com/environment/product](http://www.keysight.com/environment/product) for more information.





# Contents

## 1 Introduction

Customer Responsibilities . . . . .	11
Plan the Chassis Installation . . . . .	12
Chassis Dimensions and Weight . . . . .	12
Chassis Ventilation . . . . .	13
AC Line Voltage Requirements . . . . .	13
Acoustic considerations . . . . .	13
Other considerations . . . . .	14
Electrostatic Discharge (ESD) Precautions . . . . .	15

## 2 Receive and Uncrate the Chassis

Inspect for damage . . . . .	17
Inventory the Shipment . . . . .	17
Uncrate the chassis . . . . .	18

## 3 Connect the Chassis to the AC Power Line

Mains Disconnect . . . . .	22
Safety ground connection . . . . .	23
Connecting Power to the Chassis . . . . .	24
120 VAC (Low Line) . . . . .	26

## 4 Rack Mount the Chassis

General Rackmounting Guidelines . . . . .	29
Procedure . . . . .	31
Space and Airflow Requirements . . . . .	34
Installing Multiple Chassis in a Rack . . . . .	35

## 5 Additional Information

After Installation . . . . .	37
Service and Support . . . . .	38
Agilent On The Web . . . . .	38
Agilent by phone . . . . .	38
Product Warranty . . . . .	38
Safety-Related Specifications . . . . .	40

## A Power Cords

Y1235A: Single-phase, no Neutral, 250 VAC, NEMA L6-30P, 2.5M (8.2ft) .	43
Y1236A: 3-phase Wye (with Neutral), 240/415 VAC, IEC 60309, 2.5M (8.2ft)	44

Y1237A: 3-phase Delta/Wye, no Neutral, 250 VAC, NEMA L15-30P, 2.5M (8.2ft) . . . . . 45  
Y1238A: 3-phase Wye with Neutral, 240/415 VAC, Stripped End, 2.5M (8.2ft) 45



# 1 Introduction

Thank you for purchasing Agilent's M9514A AXIe 14-slot Chassis. To get you started and to assure a successful and timely installation, we've developed this Site Preparation Guide. Please read it carefully and follow all guidelines.

Correct site preparation is the key first step in ensuring that your chassis and software system operate reliably over an extended lifetime. This document is an information guide that outlines the utility requirements, space, and supplies for your chassis for your site.

After preparing the site and installing the M9514A chassis, review the:

- *M9514A AXIe Chassis Startup Guide*. It provides chassis verification, installing AXIe instrument modules, connecting to a remote host computer or using an embedded controller.
- *M9521A AXIe System Module Startup Guide*. Provides installation and startup information about the M9521A ASM
- *M9514A and M9521A User Guide*. It provides detailed information about the chassis, troubleshooting and service information, etc.

Both of these guides are available on the on the *Software and Product Information CD* that ships with your chassis.

## Customer Responsibilities

Make certain your site meets the following requirements prior to the installation. Details on these requirements are provided in this document.

- 
- Operating environment (cooling, noise, etc.) is suitable. (page 12 and page 40)
- 
- Receiving and transportation requirements are met (including uncrating). (page 17)
- 
- The necessary bench top or rack space is available. (page 12 and page 17)
- 
- AC power requirements, power cords, etc. are met. (page 12 and page 21).  
Customer provides power cord (from mains disconnect to chassis) and IEC 60309 (3P+N+E, 6H Red) receptacle.
- 
- Additional supplies (host computer, PCIe adapter, cables, LAN, etc.) are available.
- 

If you have questions or problems in providing anything described in the Customer Responsibilities checklist above, please notify your local Agilent support/service organization for assistance prior to delivery.

## Plan the Chassis Installation

The M9514A can be used as either as a bench top or rack mounted chassis. Consider your anticipated chassis weight (with modules installed), power, noise, ventilation requirements, and rack mounting options to ensure safety and optimize access to test and control instrumentation.

You may want to create a complete system plan diagram for your site. A system plan diagram details power availability, communications cabling, and system placement with respect to other equipment. It can also serve to verify physical access for operators and maintenance personnel.

The following figure shows a typical layout for a rack containing an M9514A AXIe chassis. You should allow one meter of space in front of the rack for operator access and one meter of space behind the system for service.

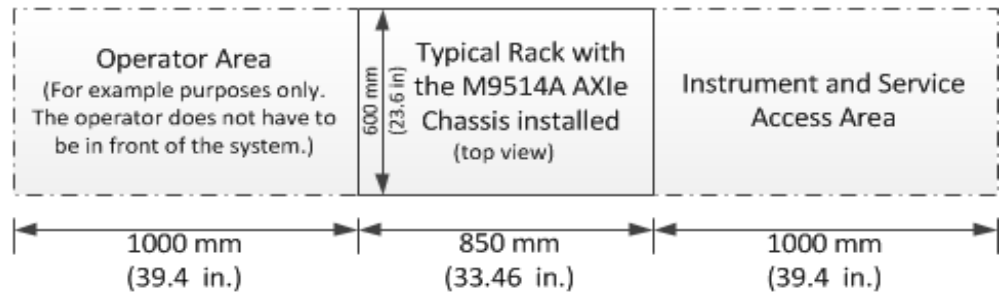

## Chassis Dimensions and Weight

Identify the bench top or rack space before the chassis arrives using the specifications below. See also, “[Rack Mount the Chassis](#)” on page 29.

Weight*	Height	Depth†	Width
107 lbs 48.7Kg	23.125 in 589.7 cm	23.75 in 579.7 cm	19 in 482.6 cm

\* weight does not include M9521A ASM or any other AXIe modules installed in the chassis.

† From front handle to 3-phase IEC 60309 connector

### WARNING



**Chassis exceeds 48 kg. Use a mechanical lift to lift the chassis. The chassis should be transported using a rolling cart. Do not lift the chassis by the handles on the front and rear of the chassis. If you plan to mount the chassis at the top of a rack (see “[Installing Multiple Chassis in a Rack](#)” on page 35) the mechanical lift must be able to raise the chassis to approximately 60” (1.5 meters).**

## Chassis Ventilation

The chassis is designed to dissipate 200 W per module slot. Depending on load, the chassis and power supply fans may exhaust significant heat. Operate in a well ventilated (or air conditioned) environment. Allow 50 mm (2 in.) clearance on both side of the chassis and 100 mm (4 in.) on the rear of the chassis.

**CAUTION**

Do not block the front fan air intake vent holes nor the fan exhaust area on the chassis. This may overheat and damage components.

---

## AC Line Voltage Requirements

The M9514A comes prewired for a 3-phase Wye with Neutral configuration for use with 220/380V, 230/400V, and 240/415C AC lines. Please consult Agilent Support if you need otehr power entry configurations.

**WARNING**

Avoid overloading an electrical circuit. Ensure your AC line matches the AC Input requirements. If you need to power down the chassis in an emergency, make sure that you have clear and quick access to the primary disconnect. Refer to “Mains Disconnect” on page 22.

---

**CAUTION**

This chassis has an auto-ranging line voltage input, be sure the supply voltage is within the specified range.

---

## Acoustic considerations

Because of the volume of air that the chassis must move to adequately cool the AXIe modules, the noise level around the chassis can exceed 79 dBA. You may need to provide sound/noise mitigation in the room where the chassis/rack is installed. Multiple chassis in a rack, plus the rack heat extractor fan noise, should be considered. Ambient noise levels in the room may be reduced with:

- Dropped ceiling -- covered with a commercial grade of acoustic fiberglass (flame-resistant) ceiling tile
- Sound deadening -- cover the walls with sound deadening material
- Removable partitions -- Use foam rubber models for most effectiveness.

**WARNING**

Hearing protection must be worn when working on or around the chassis when it is powered on. The airflow noise around the chassis can exceed 79 dB(A). This is outside the range that is normally considered safe (70 dB(A)). Over and above that level is considered hazardous and can result in permanent hearing damage.

---

## Other considerations

### CAUTION

This product is designed for use in Installation Category II Pollution Degree 2.

### Computer requirements, software, etc.

To install and run the required software (Microsoft .NET, Agilent IO Libraries version 16.3 Update 2 or later, and chassis device drivers), the host PC requires the following:

	Recommended
Operating System	Windows 7 (SP1), 32-bit or 64-bit Windows 8.1, 32-bit or 64-bit
Browser	Microsoft Internet Explorer 6 (or later)
Processor	800 MHz or greater
Minimum RAM	4 GB for 32-bit OS 8 GB for 64-bit
Available Hard Disk Space	1.5 GB
Graphics	Support for DirectX 9 graphics with 128MB graphics memory recommended

Agilent's M9536A AXIe Embedded Controller requires Windows Embedded System 7 32- or 64-bit Operating System. 8 GB RAM minimum recommended.

In addition, the host PC must be able to enumerate the AXIe chassis.

### NOTE

Many computers are not capable of enumerating a sufficient number of PCIe slots to ensure that slots in an external chassis are enumerated. Agilent maintains a *PXI and AXIe Modular Instrumentation Tested Computer List -- Technical Note* the integrated, rack mount, desktop and laptop computers that have been verified to properly enumerate PCIe devices in the AXIe chassis, at [www.agilent.com/find/axie-chassis](http://www.agilent.com/find/axie-chassis).

Agilent's M9536A Embedded Controller must have BIOS AG16 or later.

**Local Area Network** Your Agilent M9514A AXIe chassis communicates with the external host pc either by PCIe connection or by IEEE 802.3 Local Area Networking (LAN). All the necessary software and licensing comes with the chassis but you will need to purchase and install the cabling and associated hardware external to the chassis. Refer to the *M9514A and M9521A User Guide* for additional information.

## Electrostatic Discharge (ESD) Precautions

### CAUTION

Agilent's AXIe chassis and instrument modules are shipped in materials which prevent static electricity damage. These instruments should only be removed from the packaging in an anti-static area ensuring that correct anti-static precautions are taken. Store all modules in anti-static envelopes when not installed.

Electrostatic discharge (ESD) can damage or destroy electronic components. All work on electronic assemblies should be performed at a static-safe work station. The following figure shows an example of a static-safe work station using two types of ESD protection. Purchase acceptable ESD accessories from your local supplier.

- Conductive table-mat and wrist-strap combination.
- Conductive floor-mat and heel-strap combination.

Both types, when used together, provide a significant level of ESD protection. Of the two, only the table-mat and wrist-strap combination provides adequate ESD protection when used alone. To ensure user safety, the static-safe accessories must provide at least 1 M $\Omega$  of isolation from ground.

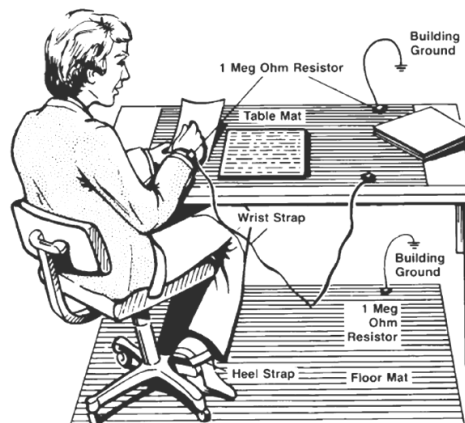



## 2 Receive and Uncrate the Chassis

### WARNING



Chassis exceeds 48 kg. Use a mechanical lift to lift the chassis. The chassis should be transported using a rolling cart. Do not lift the chassis by the handles on the front and rear of the chassis. If you plan to mount the chassis at the top of a rack (see “Installing Multiple Chassis in a Rack” on page 35) the mechanical lift must be able to raise the chassis to approximately 60” (1.5 meters).

### Inspect for damage

Before unpacking the chassis, carefully inspect the shipping container for any shipping damage. Report any damage to the shipping agent immediately, as such damage is not covered by the warranty.

To find warranty information on your M9514A AXIe chassis, go to [www.agilent.com/find/warranty](http://www.agilent.com/find/warranty) and enter your model number (M9514A) in the **Product Number** field, and enter the serial number from the chassis rear panel in the **Serial No.** field.

### CAUTION

To avoid damage when handling the AXIe chassis and modules, do not touch exposed connector pins.

### Inventory the Shipment

Use the packing list that comes with your system to ensure you received all pieces of the system.

Your shipment should include the following:

- M9514A Chassis<sup>1</sup> (does not include slot covers)
- A box inside the shipping container with:
  - M9514A Site Preparation Guide (printed version)
  - M9514A Startup Guide (printed version)
  - Power cord.

- Agilent Chassis Software and Product Information CD (contains PDF files of: **M9514A Startup Guide, M9514A Site Preparation Guide, M9514A and M9521A User Guide, M9514A Service Guide**, data sheet and more)
- Agilent IO Libraries Suite 16.3 Update 2, Agilent Automation Ready CD
- If you ordered an Agilent M9521A AXIe System Module, it will come in a separate package.

## Uncrate the chassis

At least 48 inches (1219 mm) of clearance is required all the way around and above the chassis crate to enable removing of the packing material. Refer to the one-page Quick Start Guide supplied on the small box packaged with your chassis.

### WARNING



**Chassis exceeds 48 kg. Use a mechanical lift to lift the chassis. The chassis should be transported using a rolling cart. Do not lift the chassis by the handles on the front and rear of the chassis. If you plan to mount the chassis at the top of a rack (see “[Installing Multiple Chassis in a Rack](#)” on page 35) the mechanical lift must be able to raise the chassis to approximately 60” (1.5 meters).**

Follow the steps below to uncrate the M9514A chassis.

- 1 Cut and remove the straps around the shipping carton.
- 2 Lift off the top cover of the shipping carton.
- 3 Locate and remove the two small boxes on top of the chassis. These two small boxes contain the power cord (if you ordered one), the printed documentation (this Site Preparation Guide and the M9514A Startup Guide).
- 4 Lift off the shipping carton.
- 5 Use a mechanical lift to lift the M9514A and packaging from the base of the shipping carton.
- 6 While the chassis is still on the mechanical lift, remove the packaging foam and protective plastic from the chassis.
- 7 Place the chassis on a work bench. Do not rack mount it yet.
- 8 Configure the AC power (if required). The default configuration is for 3-Phase Wye with Neutral suitable for 220/380 VAC, 230/400 VAC, or 240/415 VAC. Refer to “[Connect the Chassis to the AC Power Line](#)” on page 21 in this manual for detailed information.
- 9 Rack mount the chassis (if required). Refer to “[Rack Mount the Chassis](#)” on page 29 in this manual.



**10** Refer to the M9514A Startup Guide for information on setting up and using the M9514A chassis.

Designed for large system testing, the M9514A provides 14 AXIe slots (1 slot for the AXIe System Module plus 13 instrument module slots).

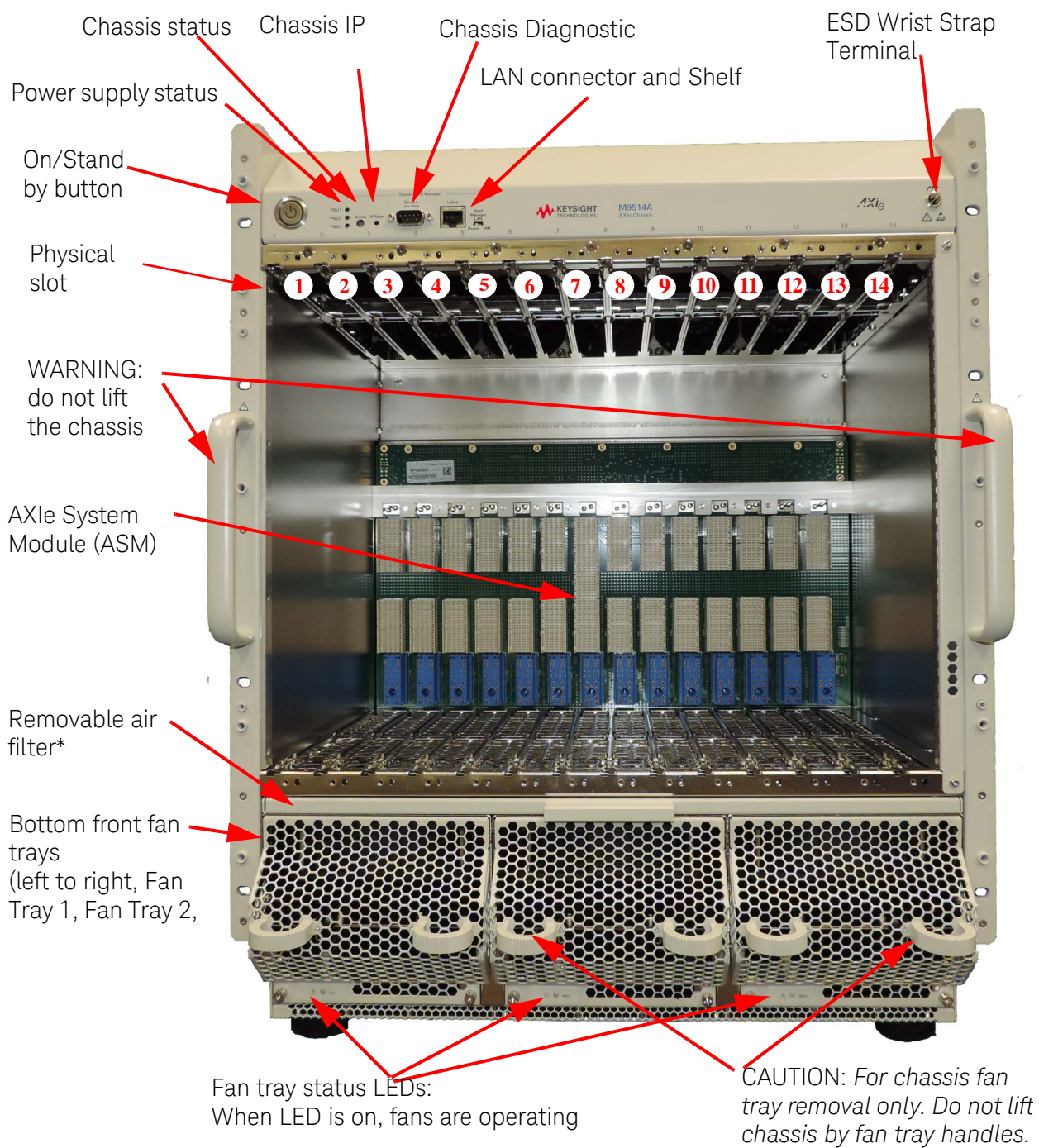

\* For detailed information, refer to M9514A and M9521A

The following graphic shows the M9514A side and rear panels.

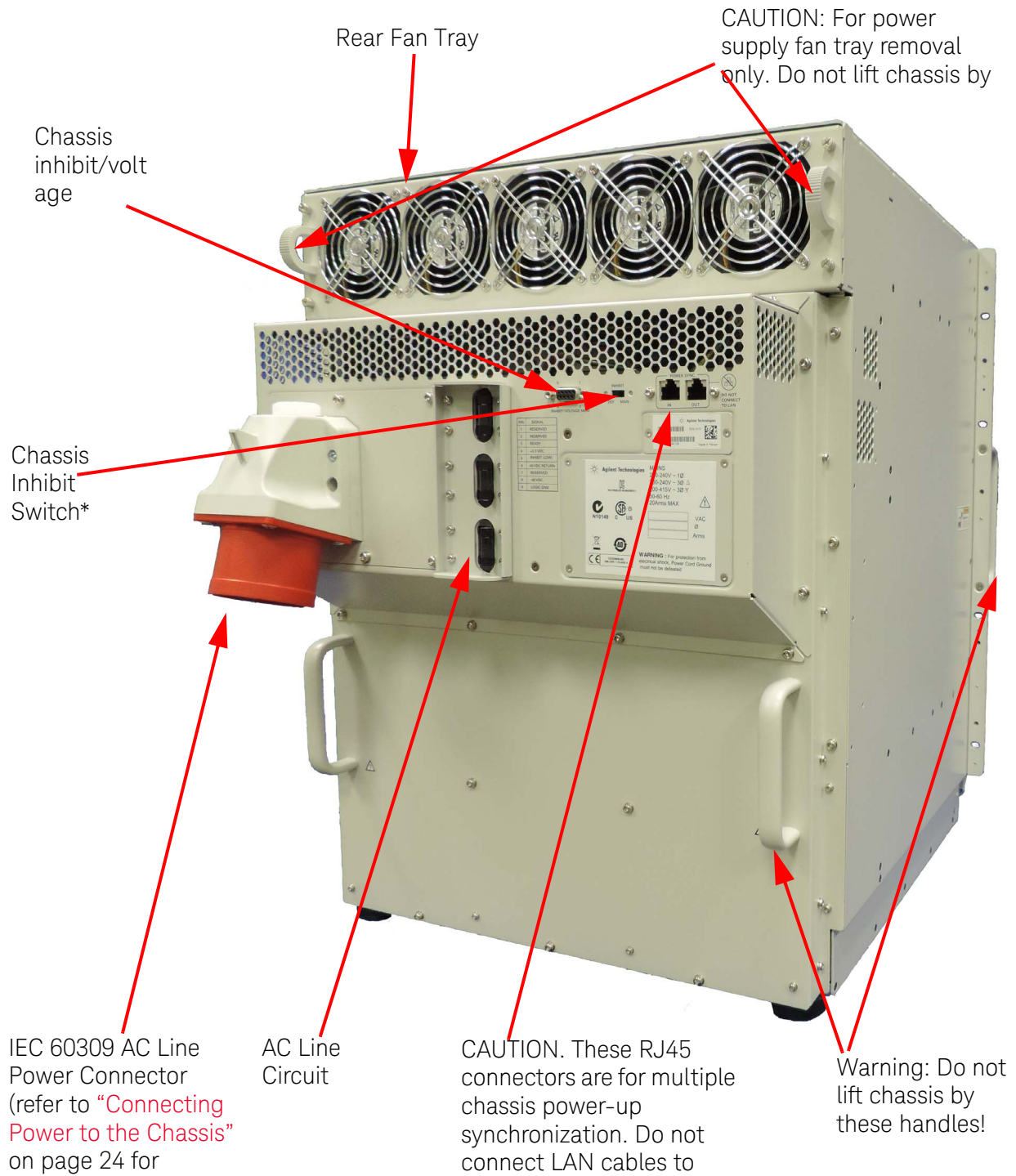

\* For detailed information, refer to *M9514A and M9521A User Guide*

# 3 Connect the Chassis to the AC Power Line

It is the customer's responsibility to:

- Prepare the site with adequate AC power for the system
- Provide a power cord (from the AC line mains disconnect to the chassis)
  - Four power cords are available from Agilent for the M9514A:
    - Y1235A for 1-phase, no Neutral, 250VAC, NEMA L6-30P, 2.5 M (8.2 feet)<sup>1</sup>
    - Y1236A for 3-phase, Wye with Neutral, 240/415VAC, IEC 60309, 2.5 M (8.2 feet)<sup>1</sup>
    - Y1237A for 3-phase, Delta/Wye, no Neutral, 250VAC, NEMA L15-30P, 2.5 M (8.2 feet)<sup>1</sup>
    - Y1238A for 3-phase, Wye with Neutral, 240/415VAC, Stripped End, 2.5 M (8.2 feet)<sup>1</sup>

Refer to [Appendix A](#), "Power Cords," starting on page 43 for detailed information about the Agilent power cords.

- An IEC 60309 (3P+N+E, 6H Red) plug is installed on the chassis at the factory. This can be used for connecting the above Agilent power cords.
- Connect the system to the AC power source.

Those responsible for the proper design and installation of the power distribution system must have a thorough knowledge of the appropriate local and regional electrical codes and the limitations of the power system.

## Mains Disconnect

**WARNING**

**AC wiring and the Mains Disconnect is subject to local and regional electrical codes. A licensed electrician must determine and install the appropriate Mains Disconnect.**

**Copper wire must be used in the power drop. A licensed electrician must determine the wire size for the power drop according to local and regional codes. The wires must be sized to ensure that the voltage at the system does not drop below 90% of the nominal voltage.**

---

For both single-phase and 3-Phase AC Line operation, a mains disconnect - providing over-current and short circuit protection - must be provided. It disconnects the mains circuits from the mains supply. It may be a switch disconnect or a circuit breaker. The front panel switch is only a standby switch and is not a LINE switch (disconnecting device).

- If a switch disconnect is used, it must:
  - Each phase must be appropriately rated.
  - Open all line conductors and neutral conductors where local code applies, but do not open the protective earth conductor.
  - Be marked "System Mains Disconnect" or the equivalent in your language.
  - Be marked with a "I" for the "On" position or a "O" for "Off."
  - Be capable of being locked in the "Off" position but not in the "On" position.
  - Be installed within three meters of the chassis, where it can be easily reached by the system operator without requiring the system to be moved to access the disconnect.
- If a circuit breaker is used, it must meet all of the switch requirements above plus:
  - Be rated for a appropriate amps interrupting capability capacity (AIC) if used on a 200-240 volt circuit .

Convenience outlets should be installed near the system for external equipment such as computers and monitors, etc. Locate the outlets within 1 meter (three feet) of the rear of the system.

## Safety ground connection

This chassis must be grounded properly for proper operation and safety. Because the M9514A is connected to the AC mains by a plug/socket connection, a permanent earth ground must be supplied to reduce the risk of electric shock.

Make a permanent connection from the system rack to protective earth ground. This connection serves as a redundant Protective Earth Connection to the primary Protective Earth connection, which is part of the AC power cord. Refer to [Figure 1](#). The “Earth (ground) terminal” found at the bottom of a system rack should be connected by a wire separate from the AC power cord to the Protective Earth connection at the AC source where the system AC power cord is connected. The wire must be the same wire size as the protective conductor of the system AC power cord. The wire may be either a bare conductor or a green with yellow stripe insulated conductor.

The redundant Protective Earth connection wire should have a correctly sized wire lug on both ends. The wire lugs should also be sized to fit the “Earth (ground) terminal” stud or bolt as found on the system rack and for the Protective Earth connection at the source end of system AC power cord. In some cases, the Protective Earth connection at the source end of the system AC power cord will receive the conductor without a wire lug.

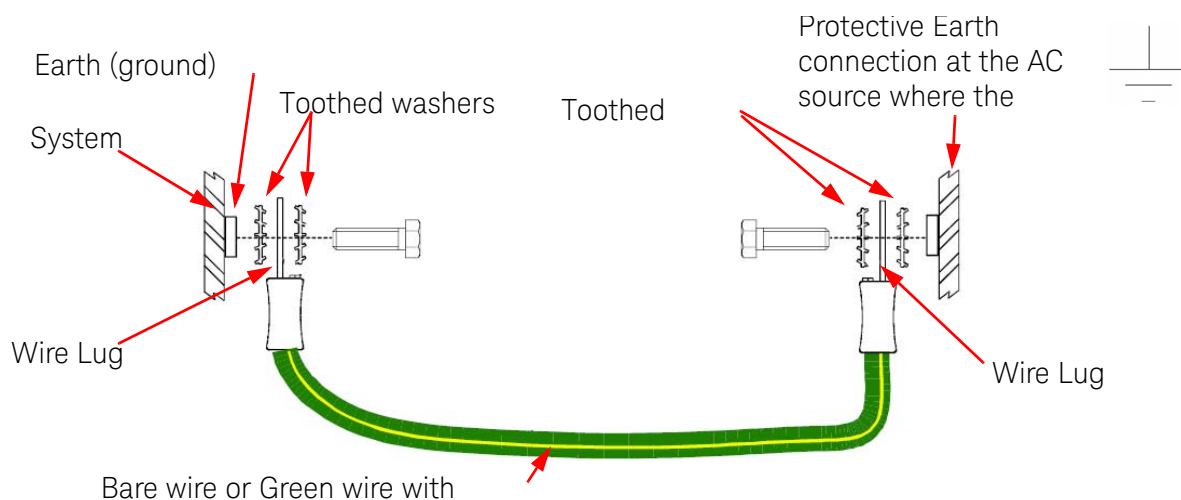

**Figure 1** Safety Ground Connection -- wire is not included with the chassis

### NOTE

The Safety Ground wire is not supplied with the M9514A chassis.



## Connecting Power to the Chassis

The M9514A comes prewired for a 3-phase Wye with Neutral configuration for use with 220/380V, 230/400V, and 240/415C AC lines. Please consult Agilent Support if you need other power entry configurations.

It is your (the end user) responsibility to provide the power cord from the AC mains disconnect to the chassis. An IEC 60309 (3P+N+E, 6H red) receptacle is installed on the chassis for quick connect/disconnect to the AC mains.

Four power cords are available from Agilent for the M9514A:

- Y1235A for 1-phase, no Neutral, 250VAC, NEMA L6-30P, 2.5 M (8.2 feet)<sup>1</sup>
- Y1236A for 3-phase, Wye with Neutral, 240/415VAC, IEC 60309, 2.5 M (8.2 feet)<sup>1</sup>
- Y1237A for 3-phase, Delta/Wye, no Neutral, 250VAC, NEMA L15-30P, 2.5 M (8.2 feet)<sup>1</sup>
- Y1238A for 3-phase, Wye with Neutral, 240/415VAC, Stripped End, 2.5 M (8.2 feet)<sup>1</sup>

Refer to [Appendix A](#), "Power Cords," starting on page 43 for detailed information about the Agilent power cords.

An IEC 60309 (3P+N+E, 6H Red) plug is installed on the chassis at the factory. This can be used for connecting the above Agilent power cords, or you may wire your own as described in this chapter.

The IEC 60309 connector (3P+N+E, 6H Red) is a common connector for connecting 400 V, 3-phase power lines. The five pins in the connector are positioned in a circle with the earth ground (E) as the larger diameter pin. Refer to the following diagram:

<sup>1</sup> These are the AC power cord ratings, not the AC power ratings for the M9514A chassis. The Agilent M9514A chassis AC input is rated to 240 VAC line-to-line. See Appendix A for cord information.

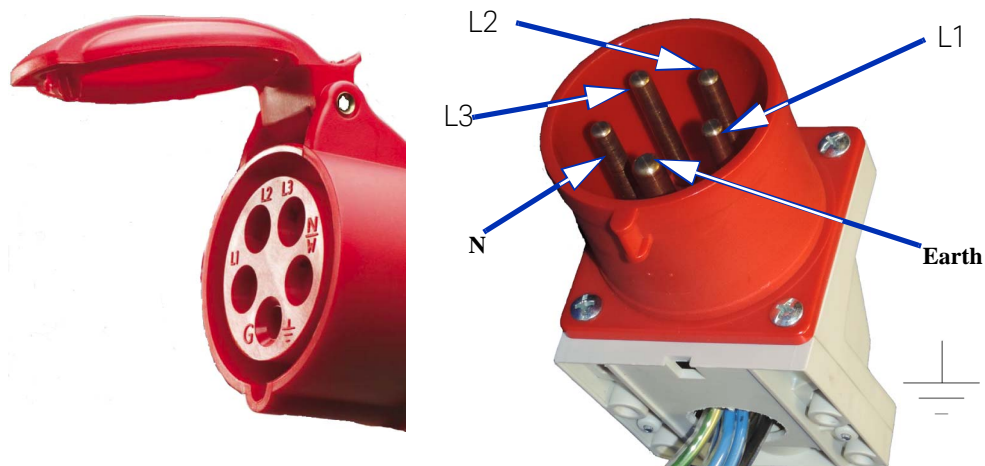

**Figure 2** IEC 60309 3P+N+E, 6H Red connector. Agilent power cords have female connector shown on left. Male connector on right is on M9514A rear panel

**WARNING**

The mains wiring and connectors shall be compatible with the connector used in the premise electrical system. Failure to ensure adequate earth grounding by not using the correct components may cause product damage and serious injury.

## 120 VAC (Low Line)

**NOTE**

Low line operation (120 VAC) is not supported on the M9514A chassis. Do not attempt to operate the chassis at low line power.

---

Low line operation (120 VAC) is not supported on the M9514A chassis. However, the chassis is designed to operate in a very limited manner if one, two or all three of the power inputs are accidentally wired to 120 VAC. This means:

- The chassis will power-up and read its various sensors.
- The power supply units (PSUs) LED will indicate that power is available to the supply. They do not discriminate between high line and low line power.
- The chassis Status LED will be red.
- The chassis will power-up the ASM.
- The chassis does not power-up any other modules.
- The chassis Soft Front Panel (SFP) will be able to connect to the chassis.
- The M9514A ASM SFP or chassis web page will be able to connect to the ASM and show the low voltage level alarm(s)
- The chassis web page displays the AC input voltages to the three PSUs. See [Figure 3](#) on page 27.

**NOTE**

The M9514A is designed to operate with an AC line voltage within the following voltage range:

Single Phase or 3-Phase Delta: 200-240 VAC

3-Phase Wye: 200/415 VAC

Do not attempt operate the chassis at low AC line voltages.

---

You can launch the Web interface from Agilent Connection Expert and view the AC line voltage from the Chassis Health web page:



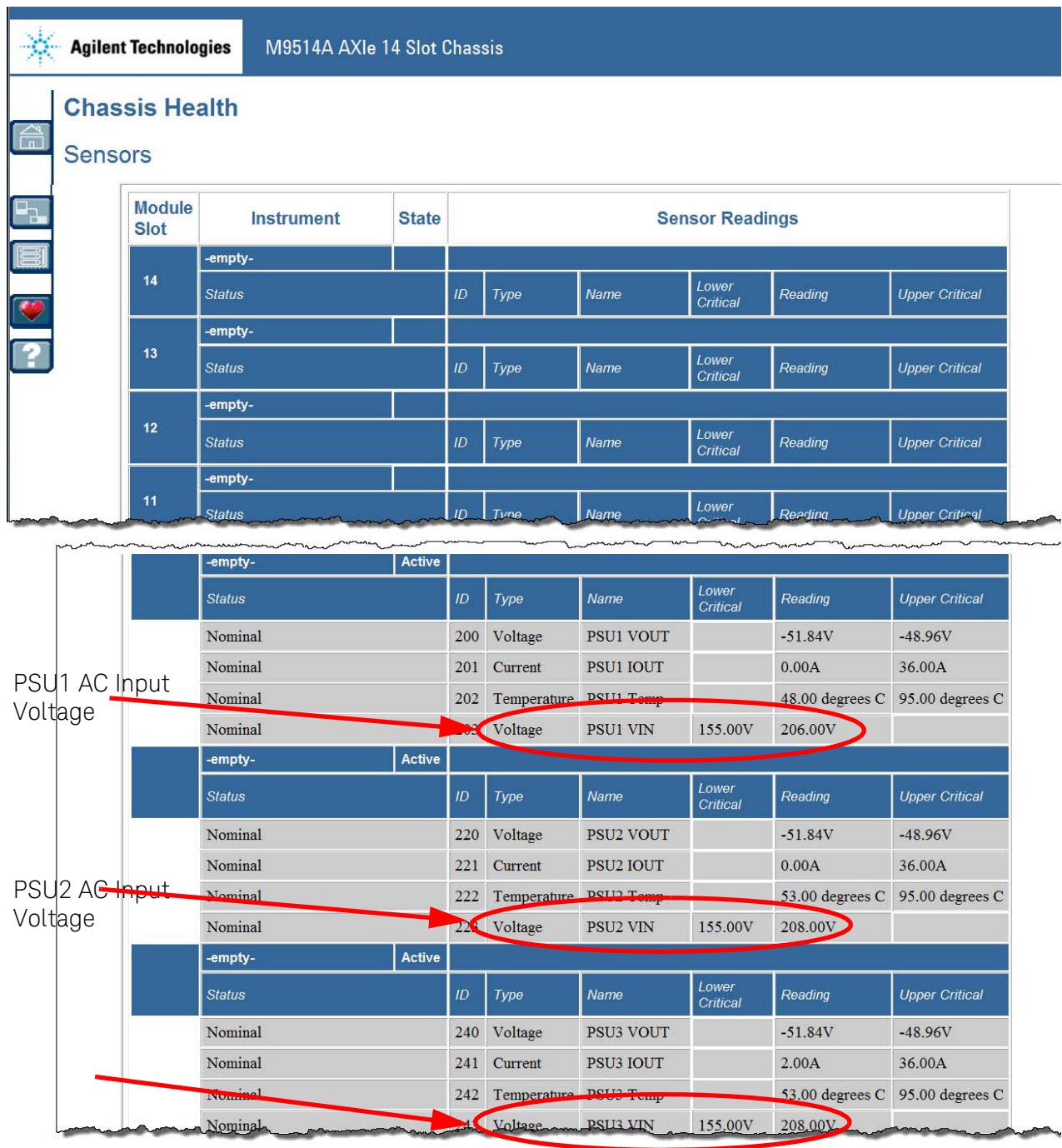

Figure 3 Normal Line voltage shown on the M9514A Web Page (shows normal AC Line voltage)

The following graphic shows the sensors reading 120VAC. Notice that the voltage lines are now red indicating Lower Non-Recoverable.

Lower Non Recoverable	203	Voltage	PSU 1 VIN	120.00 Volts
Nominal	220	Voltage	PSU 2 VOUT	51.84 Volts
Nominal	221	Current	PSU 2 IOUT	0.20 Amps
Nominal	222	Temperature	PSU 2 Temp	31.00 degrees C
Lower Non Recoverable	223	Voltage	PSU 2 VIN	121.00 Volts
Nominal	240	Voltage	PSU 3 VOUT	51.84 Volts
Nominal	241	Current	PSU 3 IOUT	3.00 Amps
Nominal	242	Temperature	PSU 3 Temp	30.00 degrees C
Lower Non Recoverable	243	Voltage	PSU 3 VIN	118.00 Volts

**Figure 4** Sensors reporting 120 VAC operation

## 4 Rack Mount the Chassis

Up to three M9514A chassis will fit in a standard (19") 2 meter rack (such as the Agilent E3662B). Use one option Y1229A Rail Kit for each rack-mounted chassis. All of the major field replaceable units (fan trays, power supplies, etc.) can be replaced while the chassis is installed in a rack.

Description of Rack Mounting Kit, Agilent Part Number	
14-Slot Chassis Rail Kit	Y1229A Rack Mounting Support Rails (includes two rails and 4 channel nuts)
Additional dress screws, channel nuts, etc.	J1622AC -- qty. 10 Torx T25 dress screws qty. 10 Torx T25 non-dress screws qty.20 20 channel nuts

### Tools needed:

- T25 Torx driver
- #1 and #2 Phillips screwdrivers
- Offset #2 Phillips screwdriver (for dress screws behind chassis handle)

## General Rackmounting Guidelines

In rack mounting the chassis, follow these guidelines:

- 1 Prior to rack mounting the chassis, you must remove the four rubber feet on the bottom of the chassis.
- 2 The rack mounting flanges are integral to the chassis itself. However, you must install rack support rails (Agilent E3664AC) to support the chassis weight. Do not use the support rails supplied with the rack.
- 3 Always begin installing the chassis and heavy instruments at the bottom of the rack and work up. The heaviest instrument, typically the chassis, should always be mounted at the bottom of the rack. This maintains a lower center of gravity and reduces the possibility of the rack tipping.
- 4 Anti-tipping feet, if available with the rack, should always be extended.
- 5 For maximum cooling and optimum rack thermal efficiency, place the instrument or chassis with the greatest power consumption towards the top of the rack. This promotes efficient cooling since heat rises. When placed nearer to the top of the rack, high power instruments will not unnecessarily heat

other instruments. However, in doing this, do not violate the guideline that the heaviest instruments should be placed at the bottom of the rack.

- 6 The recommended working space for performing maintenance is 1.2 m (4 ft) from either side of, in front of, or behind the rack. The work space must permit at least a 90 degree opening of rack doors or hinged panels.
- 7 Rack components must be properly grounded in accordance with local and regional building codes.
- 8 Ensure that rack leveling feet are properly extended to the floor and the full weight of the rack rests on the leveling feet. Anti-tip stabilizers and/or ballast are recommended.
- 9 To maintain adequate airflow, do not install front doors on the rack.

**CAUTION**

If you have been using the chassis with modules installed, you should remove all modules before rack mounting the chassis. This will make handling the chassis easier and reduce chances of damaging modules.

---

**CAUTION**

Always plan the rack installation so that the heaviest component is on the bottom of the rack. Install the heaviest item first, and continue to populate the rack from the bottom to the top.

---

**WARNING**

**Chassis exceeds 48 kg. Use a mechanical lift to lift the chassis. The chassis should be transported using a rolling cart. Do not lift the chassis by the handles on the front and rear of the chassis. If you plan to mount the chassis at the top of a rack (see “[Installing Multiple Chassis in a Rack](#)” on page 35) the mechanical lift must be able to raise the chassis to approximately 60” (1.5 meters).**

---

## Procedure

- 1 The M9514A AXIe chassis has four rubber feet on the bottom of the chassis that must be removed prior to rack mounting. Never lay the chassis on its front or back. Remove all AXIe modules from the chassis before removing the rubber feet.
- 2 Lay a blanket on the floor or workbench to protect the chassis. Carefully lay the chassis on one side on the blanket. Use a #2 Phillips screwdriver to remove the rubber feet. Store the feet and screws in case you should ever need to replace them.

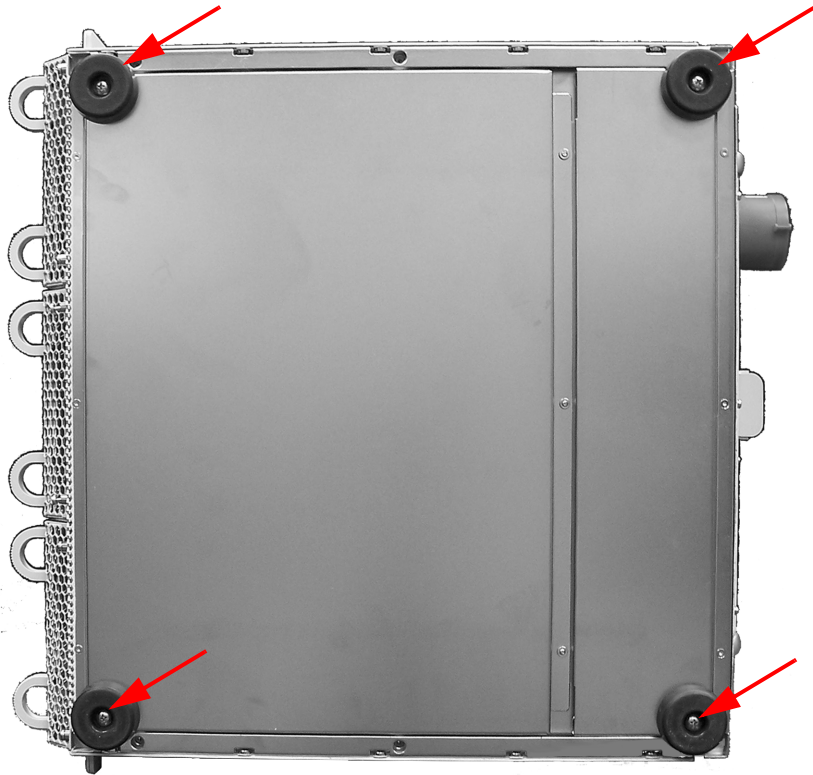

**Figure 5** Remove the four rubber feet prior to rack mounting the chassis.

- 3 Carefully set the chassis upright again.
- 4 Refer to Figure 6. Position the rack mounting support rails (E3664AC) on the rack's vertical columns where the chassis is to be mounted. Align the adapter holes over the "top" holes of the EIA rack units. On Agilent racks, the bottom of the rail should align with an arrow on the front of the rack mounting frame. Do not use the support rails supplied with the rack.
- 5 Slide clip-on sheet metal nuts over the rack holes to be used by the support rails.

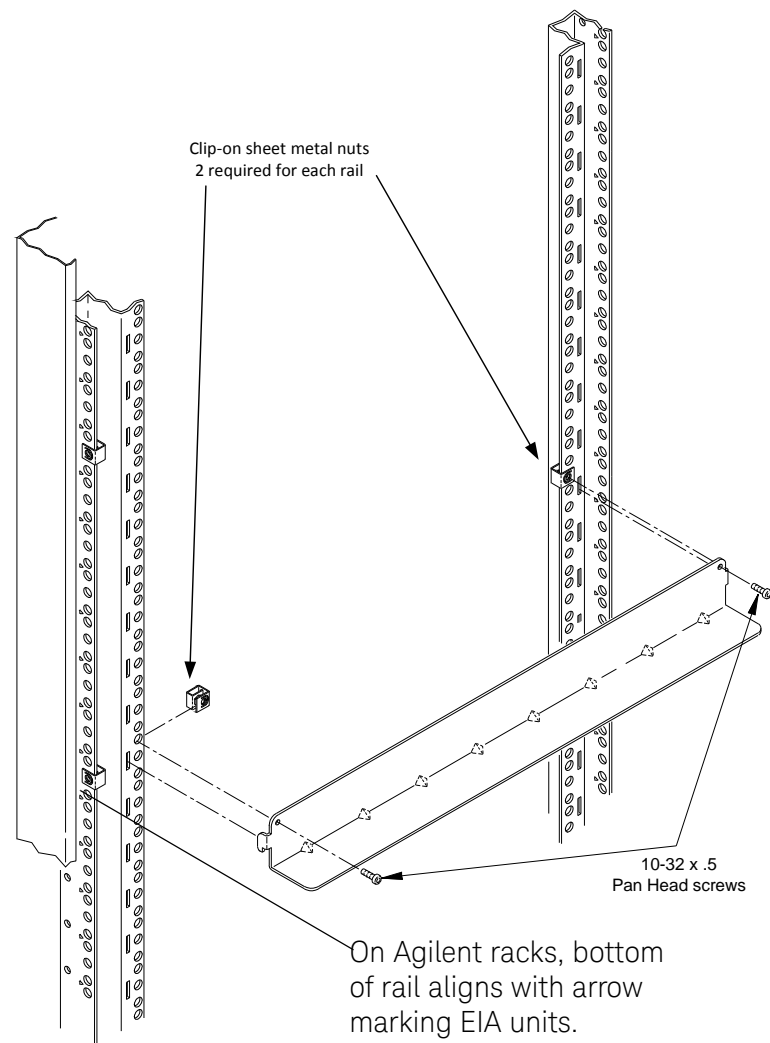
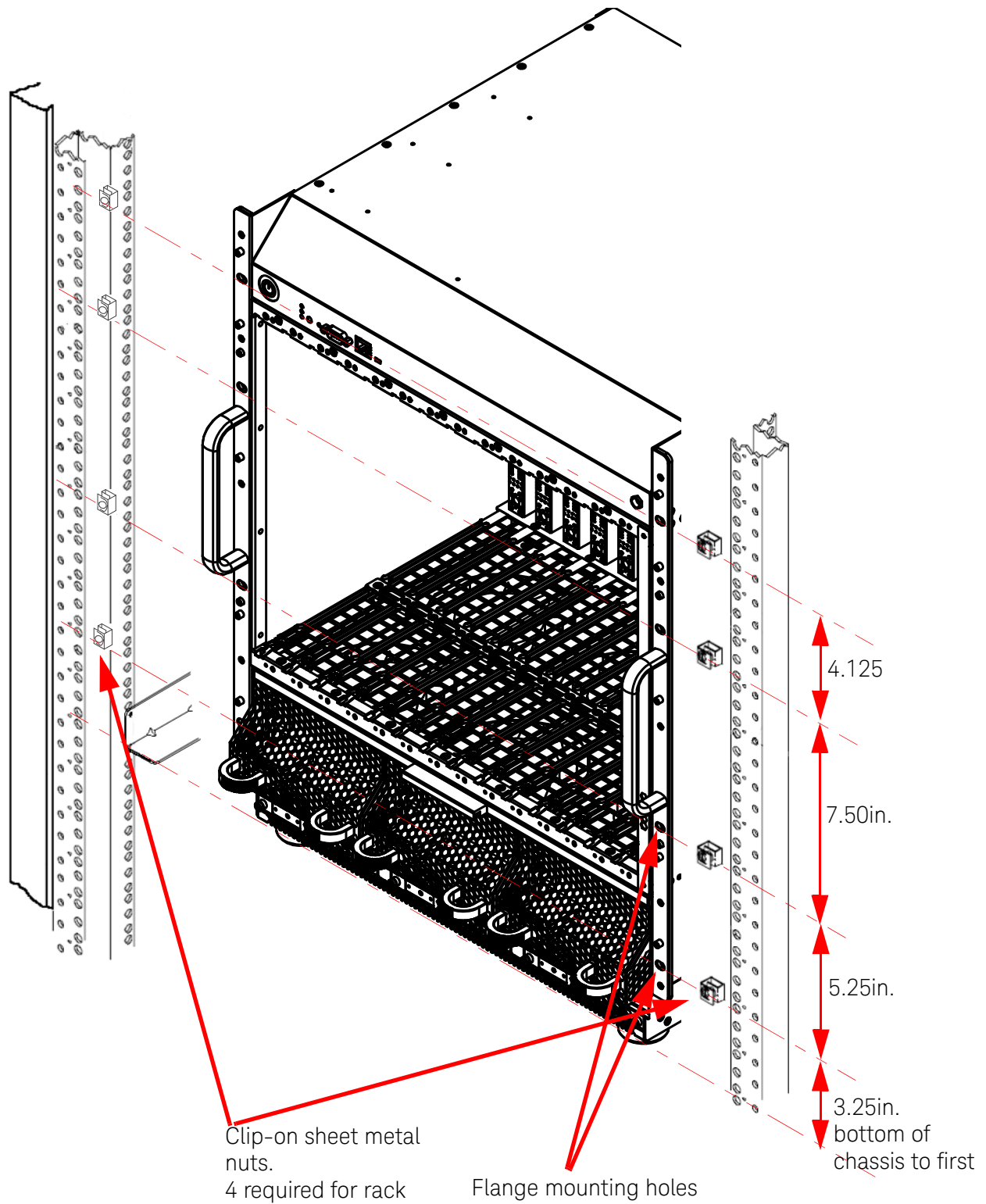

**Figure 6** Attach the Support Rails to the Rack

- 6 Attach the support rails to the rack's inside vertical columns. Use four clip-on sheet metal nuts (also called channel nuts) and the four 10-32 x 0.5 support rail-to-rack pan head screws as shown in Figure 6.
- 7 Refer to Figure 7 as a template for placing the clip-on sheet metal nuts. Mark the position the flange mounting holes on the rack's vertical columns where the chassis is to be mounted. Slide clip-on sheet metal nuts over the rack holes to be used by the rack mount flanges.

**NOTE**

For detailed chassis dimensions, refer to Appendix A in the M9514A Service Guide.



**Figure 7** Rackmounting the Agilent M9514A AXle Chassis



- 8 Set the M9514A chassis onto the support rails.

**WARNING**

**Chassis exceeds 48 kg. Use a mechanical lift to lift the chassis. The chassis should be transported using a rolling cart. Do not lift the chassis by the handles on the front and rear of the chassis. If you plan to mount the chassis at the top of a rack (see “Installing Multiple Chassis in a Rack” on page 35) the mechanical lift must be able to raise the chassis to approximately 60” (1.5 meters).**

---

**CAUTION**

Do not install the chassis upside down in the rack.

---

- 9 Slide the M9514A chassis into the rack on the rack rails until the rack mount front handle flanges are against the rack’s vertical columns. Secure the chassis to the rack using the adapter dress screws.

**NOTE**

If the rack will be moved excessively or over long distances, you should use a strap to secure the chassis to the rack support rails.

---

## Space and Airflow Requirements

The M9514A draws cool air in through the bottom front of the chassis and expels hot air through the vents at the top rear of the chassis. Therefore, the front of the rack enclosure must be adequately ventilated to enable ambient room air to enter the enclosure and the rear of the rack enclosure must be adequately ventilated to enable the hot air to escape.

**NOTE**

Do not block ventilation openings in the chassis and the rack enclosure. To maintain adequate airflow, do not install front doors on the rack.

---

If the front of the rack is not completely filled with instruments or other components, the remaining gaps between components can cause changes in airflow which can adversely affect cooling within the rack. Cover these gaps with rack blank filler panels.

**CAUTION**

**Always use blank filler panels to fill empty spaces between components in rack enclosures. This arrangement ensures proper airflow. Using an enclosure without the proper blank panels results in improper cooling that can lead to thermal damage.**

---



## Installing Multiple Chassis in a Rack

Up to three M9514A (13U) chassis may be installed in a standard 42U rack. All of the major field replaceable units (fan trays, power supplies, etc.) can be replaced while the chassis is installed in a rack.

**WARNING**

**To prevent tipping the rack, always install chassis starting from the bottom of the rack and work your way up.**

- 1 Start by installing the support rails and chassis one EIA unit up from the bottom of the rack. This prevents the rack base cover from interfering with the chassis. See [Figure 8](#) below.

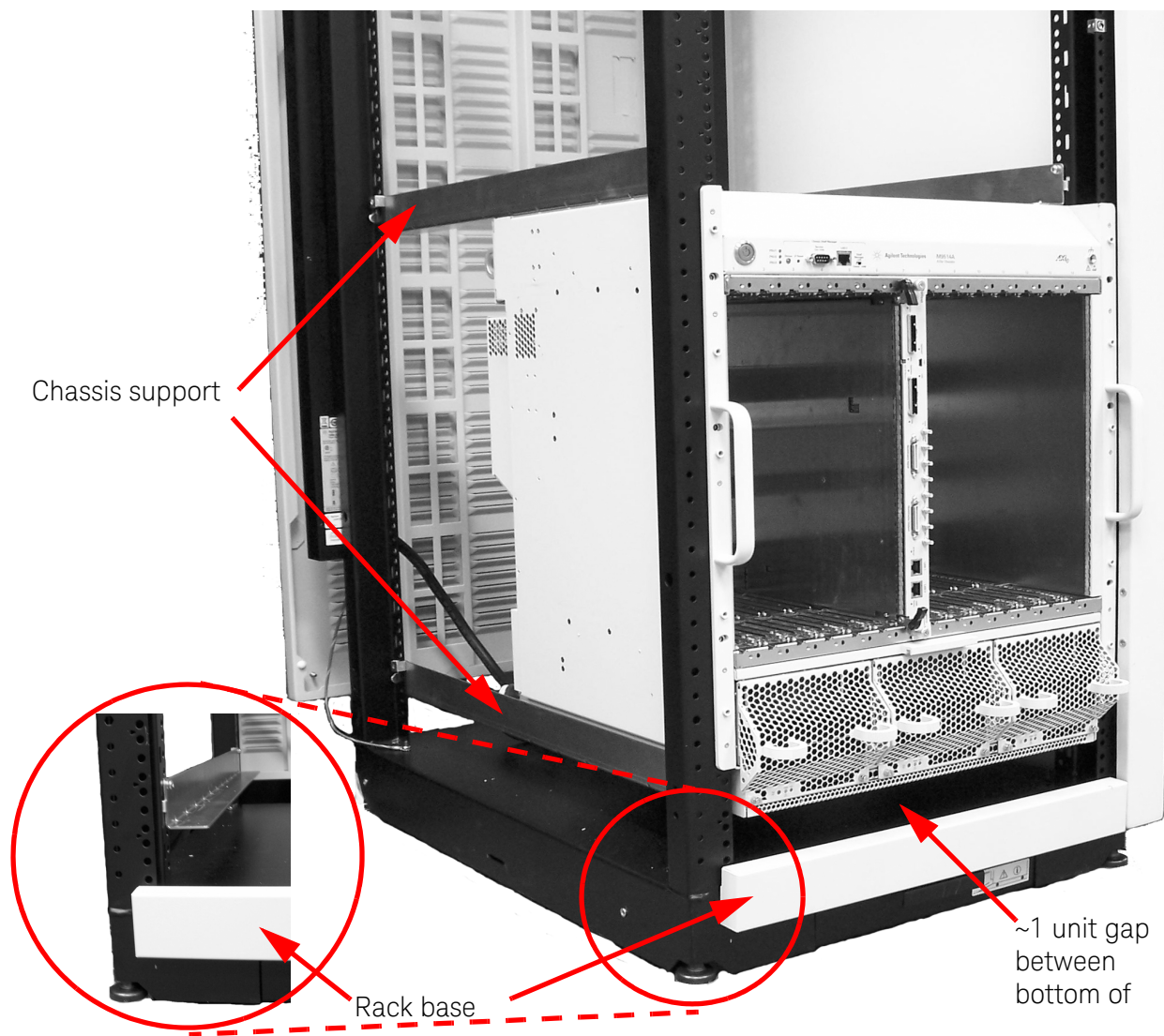

**Figure 8** For multiple chassis in a rack, install the first one at the bottom of the rack (left side panel removed for visibility in photo)

- 2 As shown in [Figure 8](#), for the next chassis, install the support rails directly on top of the first chassis. Although the rails are installed in slots in the rack, always secure the rails to the rack.
- 3 Install the second chassis on the support rails.
- 4 Likewise, to mount the third chassis (the top chassis), install the support rails directly on top of the second chassis. Ensure that the rails are securely installed on the rack. See [Figure 9](#).

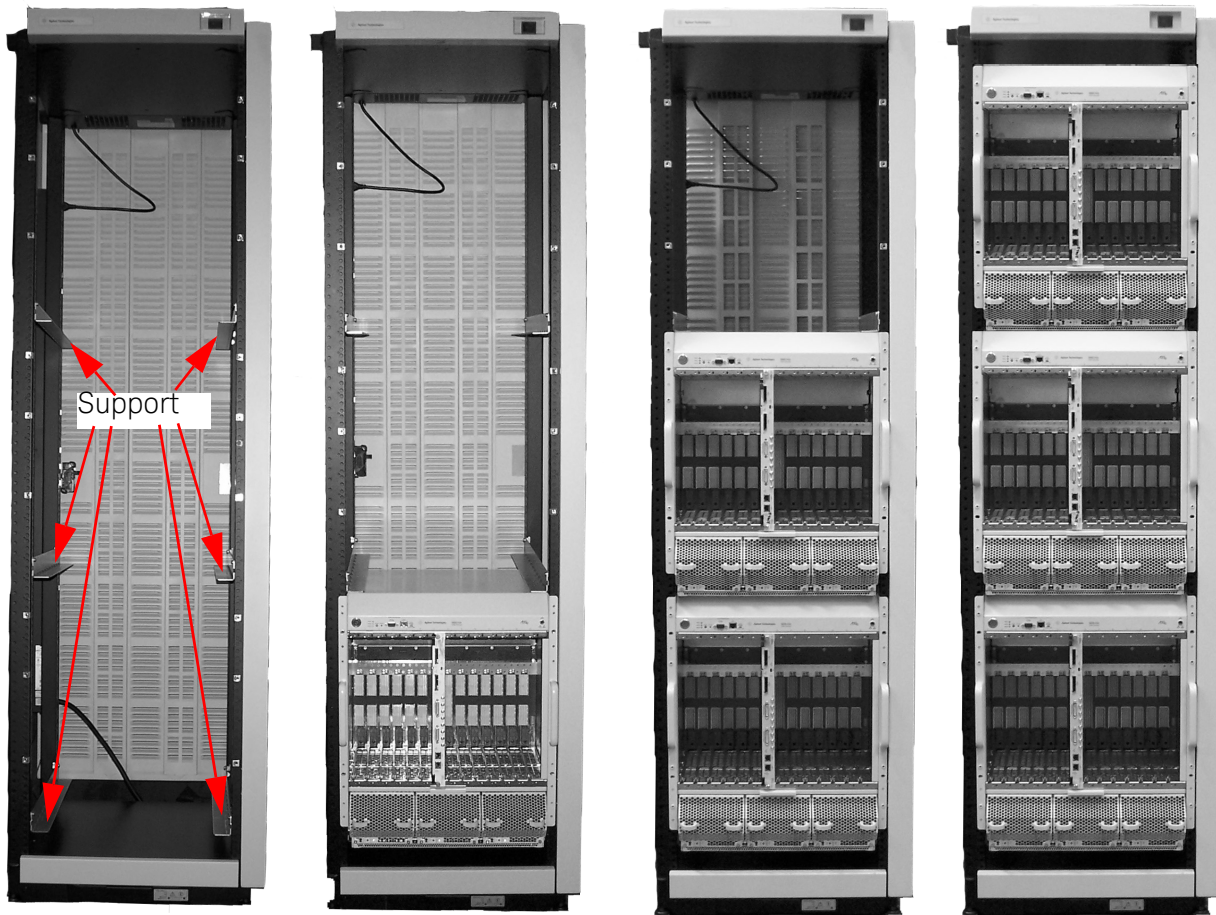

**Figure 9** Support rails for three chassis in a rack  
(left side panel removed for visibility in photo)

## 5 Additional Information

### After Installation

After uncrating, installing the chassis, and connecting AC power, you are just about ready to turn on the chassis and verify its operation.

The next manual you should read is the *M9514A AXIe Chassis Startup Guide*. This guide provides:

- A chassis overview (including a block diagram)
- Power up and power down procedures
- Information on setting up the host PC
- Installing Agilent IO Libraries Suite and other chassis-related software on the host PC

Additionally, the *Software and Product Information CD* that ships with your chassis has a PDF file of the *M9514A and M9521A User Guide*. This guide provides more detailed information about:

- Power up / power down modes
- AXIe module installation
- Using multiple chassis
- Navigating the chassis web interface and Soft Front Panel
- Various features and functions such as monitoring and controlling the chassis fan speed and temperature, chassis synchronization and triggering, and electronic E-Keying, etc.
- AXIe module development
- Chassis troubleshooting and service

## Service and Support

Do not return the M9514A AXIe chassis to Agilent for service. Any adjustment, maintenance, or repair of this product must be performed by qualified personnel. Contact your Agilent customer engineer through your local Agilent Technologies Service Center.

### Agilent On The Web

You can find information about technical and professional services, product support, and equipment repair and service on the web: <http://www.agilent.com/>

Select your country from the drop-down menu at the top. Under *Electronic Test and Measurement*, click on *Services*. The Web page that appears next has contact information specific for your country.

### Agilent by phone

If you do not have access to the Internet, call one of the numbers in the table below:

**Table 1** Agilent Call Centers and Regional Headquarters

United States and Canada:	Test and Measurement Call Center (800) 452 4844 (toll-free in US)
Europe:	(41 22) 780 8111
Japan:	Measurement Assistance Center (81) 0426 56 7832
Latin America:	305 269 7548
Asia-Pacific:	(85 22) 599 7777

### Product Warranty

To find warranty information on your M9514A AXIe chassis, go to [www.agilent.com/find/warranty](http://www.agilent.com/find/warranty) and enter your model number in the **Product Number** field, and enter the serial number from the chassis rear panel in the **Serial No.** field.



## Safety-Related Specifications

This section (next page) provides a partial set of safety-related specifications for the Keysight M9514A AXIe chassis. Complete specifications are included in the Keysight *M9514A Data Sheet*.

CHASSIS CHARACTERISTICS	
Size <sup>1</sup>	482.6 mm W x 589.7 mm H x 579.1 mm D (19 in W x 23.2 in H x 22.8 in D)
Weight (nom)	48.7 kg (107 lbs) <sup>2</sup>
<sup>1</sup> From front handle to IEC 60309 AC power connector. Top cover to rubber feet.	
<sup>2</sup> Without modules	
Power supply characteristics	
AC input	
Operating voltage range	
Single Phase or 3-Phase Delta	200-240 VAC
3-Phase Wye	200/415 VAC
Input frequency range	50-60 Hz
Input current	24 Arms
Overcurrent protection	auto recovery
Efficiency (typical)	85-93%
DC supply	
DC Output	-52 V
Total DC module power	2800 W
Total max module current	53.8A
Load regulation	2%
Maximum ripple and noise (20 MHz BW)	500 mV pk-pk
Chassis cooling and power dissipation	
Slot airflow direction	Bottom to top
Chassis cooling intake	Bottom front of chassis
Chassis cooling exhaust	Top rear of chassis
Chassis cooling fans	HIGH/Auto speed selector six 252.85 cfm fans in three front fan trays ten 138.0 cfm fans in rear fan tray
Power dissipation, instrument slot	200 W maximum

## Safety-Related Specifications

<b>Environmental<sup>*,†,‡</sup></b>		
Operating and storage conditions		
	Operating	Storage
Temperature	0°C to 50°C	-25°C to 60°C
Altitude	up to 3000 meters	up to 4600 meters
Humidity	Type tested at 95%, +40°C (non-condensing)	
Vibration		
Operating random vibration: type tested at 5 to 500 Hz, 0.21 g rms		
Survival random vibration: type tested at 5 to 500 Hz, 2.09 g rms		
M9514A Acoustical emissions (LWA dB, ref 1pW)		
	Maximum	Nominal (25°C ambient)
Sound Pressure**	79 dBA	67 dBA
Sound Power	89dBA	77 dBA

\* Characteristics apply to both M9514A and M9521A unless otherwise noted.

† Samples of this product have been type tested in accordance with the Keysight Environmental Test Manual and verified to be robust against the environmental stresses of storage, transportation and end-use; those stresses include but are not limited to temperature, humidity, shock, vibration, altitude, and power line conditions.

‡ Test methods are aligned with IEC 60068-2 and levels are similar to MIL-PRF-28800F Class 3.

\*\*At operator position.

<b>Regulatory<sup>*</sup></b>
<b>Safety</b>
Complies with European Low Voltage Directive 2006/95/EC IEC/EN 61010-1:2010, 3rd Edition Canada: CSA C22.2 No. 61010-1-12 USA: UL std no. 61010-1, 3rd Edition
<b>EMC</b>
Complies with European EMC Directive 2004/108/EC IEC/EN 61326-1 CISPR Pub 11 Group 1, Class A AS/NZS CISPR 11 ICES/NMB-001 This ISM device complies with Canadian ICES-001. Cet appareil ISM est conforme Cet appareil ISM est conforme a la norme NMB-001 du Canada

\* Characteristics apply to both M9514A and M9521A





# A Power Cords

This appendix provides information about the four power cords available for the Agilent M9514A AXIe Chassis.

**NOTE**

The Agilent Y1235A, Y1236A, or Y1238A power cords are specifically designed to be used with the M9514A chassis, you do not need to rewire the chassis power terminal block. However, if you are connecting to a 3-phase Delta or Wye without neutral using an Agilent Y1237A power cord, you will need to rewire the chassis power terminal block.

Y1235A: Single-phase, no Neutral, 250 VAC, NEMA L6-30P, 2.5M (8.2ft)

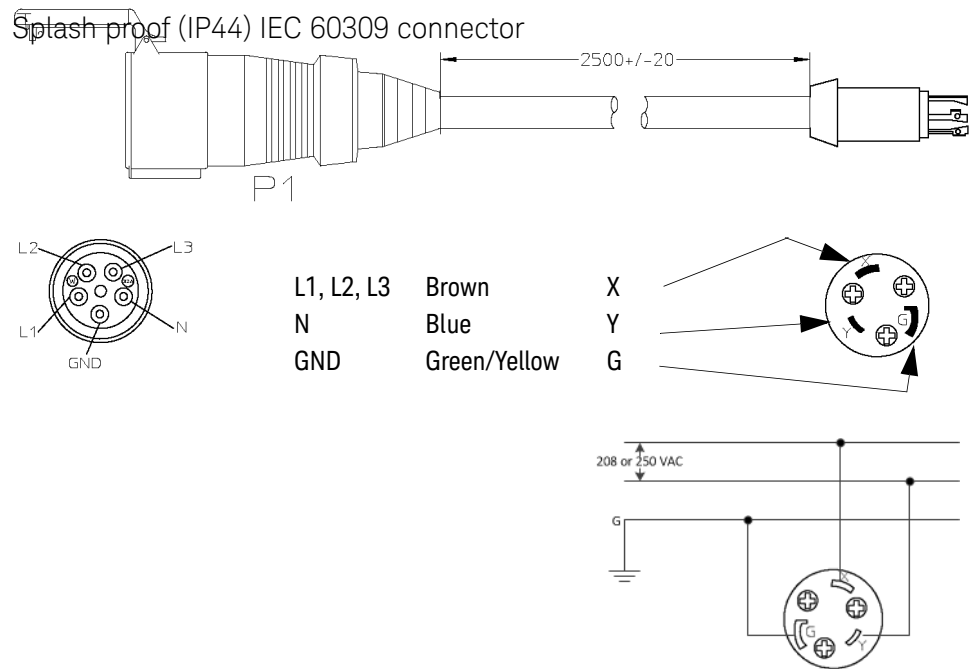

**Figure 10** Y1235A

Y1236A: 3-phase Wye (with Neutral), 240/415 VAC, IEC 60309, 2.5M (8.2ft)

Splash proof (IP44) IEC 60309 connector

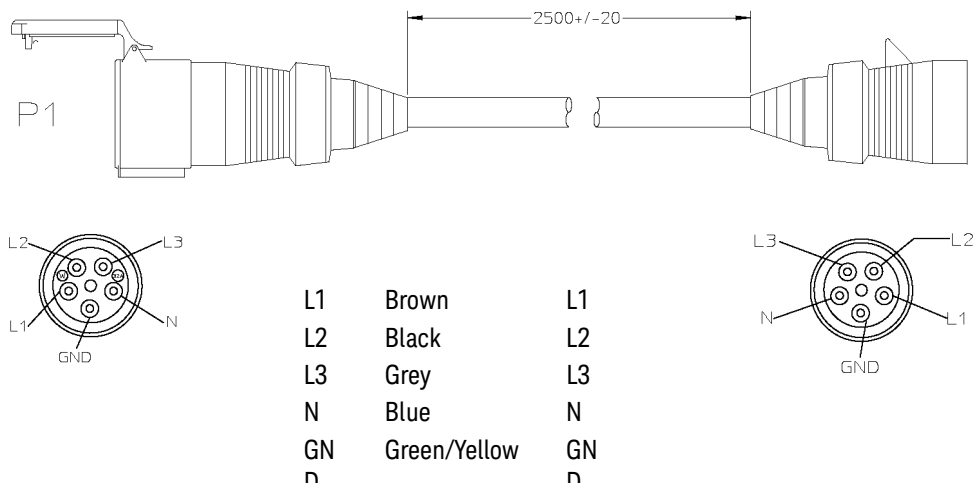

**Figure 11** Y1236A

Splash proof (IP44) IEC 60309 connector

Y1237A: 3-phase Delta/Wye, no Neutral, 250 VAC, NEMA L15-30P, 2.5M (8.2ft)

Splash proof (IP44) IEC 60309 Connector

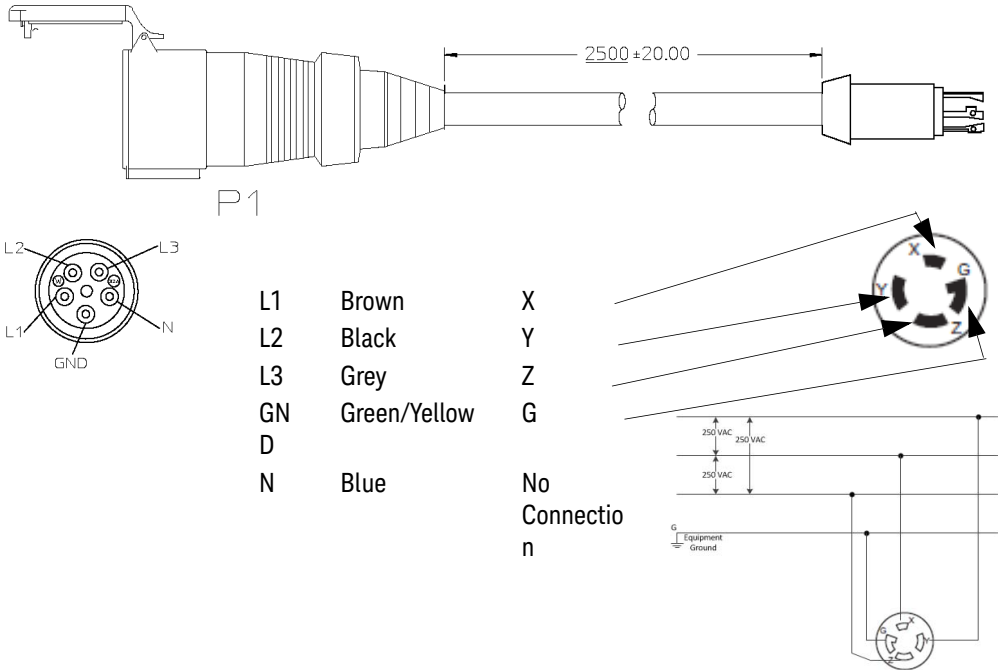

Figure 12 Y1237A

Y1238A: 3-phase Wye with Neutral, 240/415 VAC, Stripped End, 2.5M (8.2ft)

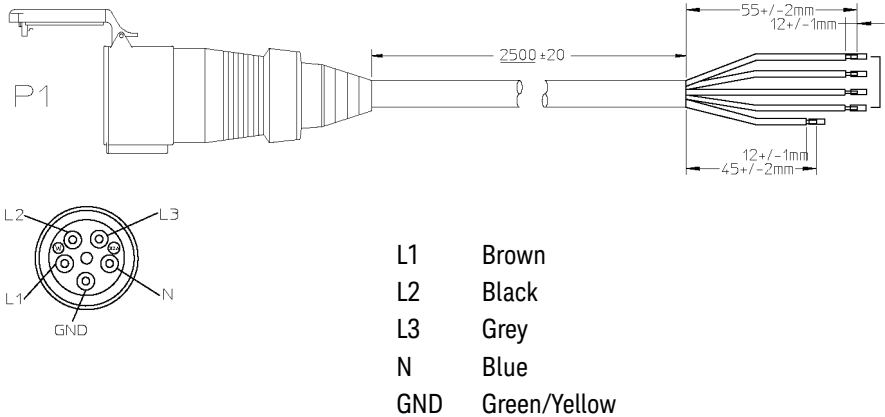

Figure 13 Y1238A

## Power Cords

myKeysight

[www.keysight.com/find/mykeysight](http://www.keysight.com/find/mykeysight)

A personalized view into the information most relevant to you.



[www.axiestandard.org](http://www.axiestandard.org)

Advanced TCA® Extensions for Instrumentation and Test (AXIe) is an open standard that extends the Advanced TCA for general purpose and semiconductor test. Keysight is a founding member of the AXIe consortium.



[www.lxistandard.org](http://www.lxistandard.org)

LAN eExtensions for instruments puts the power of Ethernet and the Web inside your test systems. Keysight is a founding member of the LXI consortium.



[www.pxisa.org](http://www.pxisa.org)

PCI eExtensions for Instrumentation (PXI) modular instrumentation delivers a rugged PC-based high-performance measurement and automation platform.



[www.keysight.com/find/ThreeYearWarranty](http://www.keysight.com/find/ThreeYearWarranty)

Keysight's combination of product reliability and three-year warranty coverage is another way we help you achieve your business goals: increased confidence in uptime, reduced coat of ownership and greater convenience.

#### Keysight Assurance Plans

Keysight Advantage Services

[www.keysight.com/find/AssurancePlans](http://www.keysight.com/find/AssurancePlans)



Five years of protection and no budgetary surprises to ensure your instruments are operating to specifications and you can continually rely on accurate measurements.



[www.keysight.com/quality](http://www.keysight.com/quality)

Keysight Electronic Measurement Group DEKRA Certified ISO 9001:2008 Quality Management System



#### Keysight Channel Partners

[www.keysight.com/find/channelpartners](http://www.keysight.com/find/channelpartners)

Get the best of both worlds: Keysight's measurement expertise and product breadth, combined with channel partner convenience.

[www.keysight.com](http://www.keysight.com)

[www.keysight.com/find/modular](http://www.keysight.com/find/modular)

[www.keysight.com/find/pxi-switch](http://www.keysight.com/find/pxi-switch)

For more information on Keysight Technologies' products, applications or services, please contact your local Keysight office. The complete list is available at: [www.keysight.com/find/assist](http://www.keysight.com/find/assist)

For other unlisted Countries:

[www.keysight.com/find/contactus](http://www.keysight.com/find/contactus)



This information is subject to change  
without notice

© Keysight Technologies 2014  
Edition 2 September 2014



M9514-90007

[www.keysight.com](http://www.keysight.com)